

D U C T M A T E

Access Doors



Square Framed Access Doors

Hinged, Cammed, & High Pressure Models

- Double gasketed
- Insulated
- Competitively priced
- Precision designed and manufactured
- Variety of sizes available
- Available in Specialty Metals



DUCTMATE[®]
Industries, Inc.

Hinge & Cam

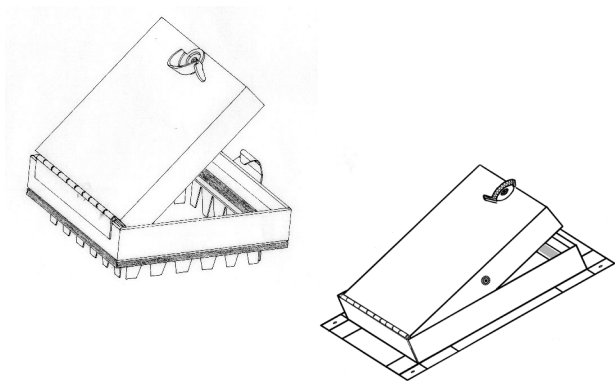

DESCRIPTION

Low pressure access door for rectangular duct

- 3" W.G. Positive
- 2" W.G. Negative

BASIC USE

To provide easy access into air ducts and units. This door was developed as an inexpensive alternative to the Ductmate Sandwich® Access Door, for low pressure applications.

SPECIAL CHARACTERISTICS

- Insulated
- Double gasketed
- Meets SMACNA requirements for low pressure doors
- Dovetail frames are available for Metal Ductwork, 1" Duct Board or 1½" Duct Board
- Press-On frames are available for metal ductwork only

TECHNICAL INFORMATION

- DOOR**
Consists of two, 24 gauge galvanized steel panels mechanically locked together
- INSULATION**
1" High density fiberglass insulation with UL classification: FHC25/50
- GASKET**
Closed cell cross-linked polyethylene gasket with a service temperature range of -70°F to 175°F. The gasket is bonded to the inside of both the Dovetail and Press-On frames and also to the outside of the Dovetail frame only. Double Sided Adhesive Gasket: Closed cell cross-linked polyethylene is UL94HF1 listed with a service temperature range of -110°F to 158°F. This gasket is bonded to the outside of the Press-On frame only.
- DOVETAIL FRAME**
Frames measuring 6" x 6" to 12" x 12" are manufactured from 24 gauge galvanized steel. Frames measuring 14" x 14" to 24" x 24" are manufactured from 22 gauge galvanized steel. All frames are manufactured with fastened corners for increased strength and an improved Dovetail design for easy installation on Metal Duct, 1" Duct Board or 1½" Duct Board.
- PRESS-ON FRAME**
Frames measuring 6" x 6" to 12" x 12" are manufactured from 24 gauge galvanized steel. Frames measuring 14" x 14" to 24" x 24" are manufactured from 22 gauge galvanized steel. A durable double sided adhesive gasket allows for easy installation to metal ductwork.
- HINGE**
Full length galvanized steel piano hinge is secured to both the frame and the door
- CAM & LATCH**
The cam is manufactured from 16 gauge galvanized steel and the latch is manufactured from 20 gauge galvanized steel. Each cam is secured to the door with a rivet. The latch is securely fastened to the frame.

Cam Latches

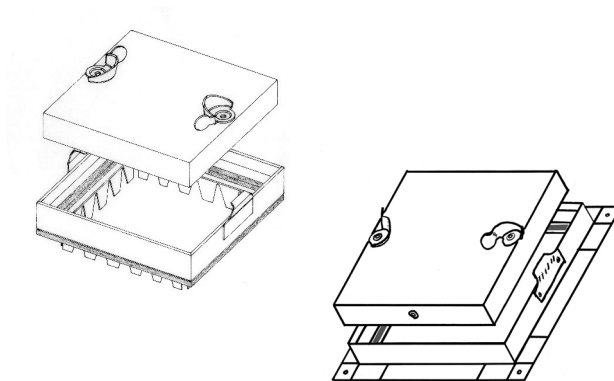

DESCRIPTION

Low pressure access door for rectangular duct.

- 3" W.G. Positive
- 2" W.G. Negative

BASIC USE

To provide easy access into air ducts and units. This door was developed as an inexpensive alternative to the Ductmate Sandwich® Access Door, for low pressure applications.

SPECIAL CHARACTERISTICS

- Insulated
- Double gasketed
- Meets SMACNA requirements for low pressure doors
- Dovetail frames are available for Metal Ductwork, 1" Duct Board or 1½" Duct Board
- Press-On frames are available for metal ductwork only

TECHNICAL INFORMATION

- DOOR**
Consists of two, 24 gauge galvanized steel panels mechanically locked together
- INSULATION**
1" High density fiberglass insulation with UL classification: FHC25/50
- GASKET**
Closed cell cross-linked polyethylene gasket with a service temperature range of -70°F to 175°F. The gasket is bonded to the inside of both the Dovetail and Press-On frames and also to the outside of the Dovetail frame only. Double Sided Adhesive Gasket: Closed cell cross-linked polyethylene is UL94HF1 listed with a service temperature range of -110°F to 158°F. This gasket is bonded to the outside of the Press-On frame only.
- DOVETAIL FRAME**
Frames measuring 6" x 6" to 12" x 12" are manufactured from 24 gauge galvanized steel. Frames measuring 14" x 14" to 24" x 24" are manufactured from 22 gauge galvanized steel. All frames are manufactured with fastened corners for increased strength and an improved Dovetail design for easy installation on Metal Duct, 1" Duct Board or 1½" Duct Board.
- PRESS-ON FRAME**
Frames measuring 6" x 6" to 12" x 12" are manufactured from 24 gauge galvanized steel. Frames measuring 14" x 14" to 24" x 24" are manufactured from 22 gauge galvanized steel. A durable double sided adhesive gasket allows for easy installation to metal ductwork.
- CAM & LATCH**
The cam is manufactured from 16 gauge galvanized steel and the latch is manufactured from 20 gauge galvanized steel. Each cam is secured to the door with a rivet. The latch is securely fastened to the frame.

High Pressure

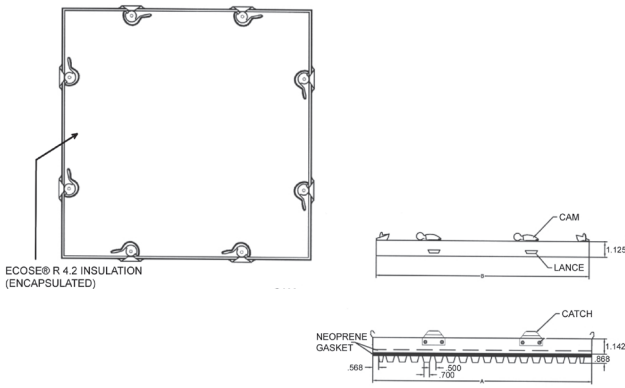

DESCRIPTION

High-pressure square-framed access door for rectangular duct.

- 10" W.G. Positive
- 10" W.G. Negative

BASIC USE

To provide easy access into air ducts and units. This door was developed as an alternative to the Ductmate Sandwich® Access Door.

SPECIAL CHARACTERISTICS

- Insulated
- Double-gasketed
- Available in specialty metals

TECHNICAL INFORMATION

- DOOR**
Consists of two 24 gauge galvanized steel panels mechanically locked together.
- INSULATION**
1" high-density fiberglass insulation with Ecosse® Technology UL Classifications: FHC25/50, ASTM C 1071; TYPE 1, ASTM G 21, Greenguard Indoor Air Quality Certified®, Greenguard Children and SchoolsSM, NFPA 90A and 90B.
- GASKET**
Closed-cell neoprene gasket is UL94HF1 listed with a service temperature range of -20 ° F to 200 ° F. The gasket is bonded to the inside and outside of the frame.
- DOVETAIL FRAME**
Frames measuring 6" x 6" to 12" x 12" are manufactured from 24 gauge galvanized steel. Frames measuring 14" x 14" to 24" x 24" are manufactured from 22 gauge galvanized steel. All frames are manufactured with spotwelds at each corner for increased strength and an improved dovetail design for easy installation on metal duct.
- CAM & LATCH**
The cam is manufactured from 16 gauge galvanized steel. The latch is manufactured from 20 gauge galvanized steel. Each cam is secured to the door with a rivet. The latch is secured to the frame in two locations for added rigidity.
- PRE-FORMED TABS**
22 gauge galvanized steel.

LIMITED PRODUCT WARRANTY

Ductmate warrants that Square Framed Access Doors, when properly installed and maintained, will be free from defects in material and workmanship, and will comply with all written specifications made by Ductmate at the time of sale. Ductmate's warranty shall run for a period of one year from the date of manufacture.

Warranty Limitation

The warranty stated above is in lieu of all other warranties, express or implied, including but not limited to the implied warranties of MERCHANTABILITY AND FITNESS FOR A PARTICULAR PURPOSE. Although Ductmate may have suggested the product, or provided written or oral advice to the Purchaser, it is the Purchaser's responsibility to test and determine the suitability of Square Framed Access Doors, for the intended use and purpose, and Purchaser and/or its customer assumes all risk and liability whatsoever regarding such suitability.

Limitation of Liability

In the event of a breach of the above warranty, Ductmate's sole obligation, and Purchaser's sole and exclusive remedy, shall be, at Ductmate's option, repair or replacement of any defective products, or refund of an applicable portion of the purchase price. Ductmate shall have no liability for costs of removal or reinstallation of the product. The Purchaser agrees that no other remedy, including but not limited to loss of profits, loss sales, injury to person or property, or any other special, incidental or consequential damages, shall be available to the Purchaser for any claim arising out of this Agreement, regardless of whether such claim is made in contract or in tort, including strict liability in tort. In no event will Ductmate be obligated to pay damages to the Purchaser in any amount exceeding the purchase price that the Purchaser paid to Ductmate for the allegedly defective product.

PACKAGING INFORMATION

Hinge & Cam

Size	Part No.	No. Per Carton	Lbs. Per Carton
6" x 6"	FD*H6GA	20	31
8" x 8"	FD*H8GA	20	45
10" x 10"	FD*H10GA	10	30
12" x 12"	FD*H12GA	10	39
14" x 14"	FD*H14GA	10	50
16" x 16"	FD*H16GA	5	30
18" x 18"	FD*H18GA	5	38
20" x 20"	FD*H20GA	5	45
24" x 24"	FD*H24GA	5	60

* 1 for 1" Duct Board, 15 for 1½" Ductboard, P for Press-On frames
Note: Two cams opposite the hinge for doors larger than 14"

Cam Latches

Size	Part No.	No. Per Carton	Lbs. Per Carton
6" x 6"	FD*C6GA	20	31
8" x 8"	FD*C8GA	20	45
10" x 10"	FD*C10GA	10	30
12" x 12"	FD*C12GA	10	39
14" x 14"	FD*C14GA	10	50
16" x 16"	FD*C16GA	5	30
18" x 18"	FD*C18GA	5	38
20" x 20"	FD*C20GA	5	45
24" x 24"	FD*C24GA	5	60

* 1 for 1" Duct Board, 15 for 1½" Ductboard, P for Press-On frames
Note: Four cams on doors larger than 14"

Rectangular Sizes are available for both hinge & cam, and cam latch models.

Doors are available up to size 36" x 36" for square or rectangular.

High Pressure

Standard sizes for all types

Size	Part No.	Frame Neck O.D.	No. of Cams
6" x 6"	FDHPC6GA	4-7/8" x 4-7/8"	4
8" x 8"	FDHPC8GA	6-7/8" x 6-7/8"	8
10" x 10"	FDHPC10GA	8-7/8" x 8-7/8"	8
12" x 12"	FDHPC12GA	10-7/8" x 10-7/8"	8
14" x 14"	FDHPC14GA	12-7/8" x 12-7/8"	8
16" x 16"	FDHPC16GA	14-7/8" x 14-7/8"	8
18" x 18"	FDHPC18GA	16-7/8" x 16-7/8"	8
20" x 20"	FDHPC20GA	18-7/8" x 18-7/8"	8
24" x 24"	FDHPC24GA	22-7/8" x 22-7/8"	8

* Available in specialty metals

INSTALLATION INSTRUCTIONS FOR DOVETAIL FRAMES

1. Trace the frame of the access door onto the duct.



2. Using a hand held plasma cutter or by conventional methods, cut the hole for the frame.



3. Open the door and place the frame into the hole you cut in step 2.

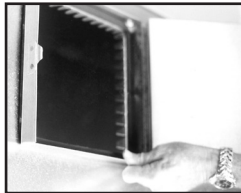

4. Bend over all of the dovetails on the frame with a hammer to ensure a tight fit.

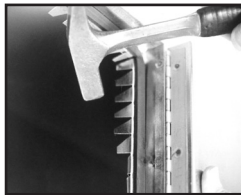

5. Close the door and latch.



INSTALLATION INSTRUCTIONS FOR PRESS-ON FRAMES

1. Without removing the cover from the adhesive backed gasket, place the opened door frame on the duct and trace around the inside of the frame.



2. Using a hand held plasma cutter or by conventional methods, cut the hole for the frame.



3. Remove the cover from the adhesive backed gasket tape.

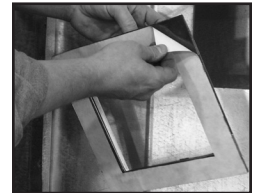

4. Open the door and place the frame over the hole you cut in step 2.

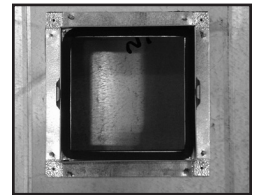

5. Using zip screws, permanently attach the frame to the ductwork. Doors 16" and smaller require one screw at each corner and one at center on each side. Doors 18" to 36" require one screw at each corner with three screws evenly spaced on each side of the frame.



6. Close the door and latch.

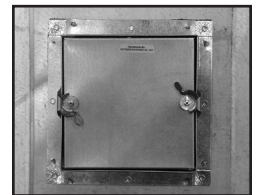

Charleroi, PA
210 Fifth Street
Charleroi, PA 15022
724-258-0500

Lodi, CA
810 S. Cluff Avenue
Lodi, CA 95240-9141
209-333-4680

*Additional Manufacturing and Warehousing in
Monongahela, PA and Wagoner, OK*

1-800-245-3188 • www.ductmate.com

© Copyright Ductmate Industries, Inc. All rights reserved.



Ductmate Is A Proud Member Of The Following Organizations:



Distributed By: